

# INSIGNIA PRICE/SPECIFICATION GUIDE

1 April 2017 | Model Year 2017.5



# INSIGNIA COMPANY CAR DRIVER/FLEET INFORMATION

## DESIGN AND TECH LINE HIGH SPEC, LOW P11D

Specifically developed for businesses and company car drivers alike, our Design and Tech Line models are seriously fit for Fleet.

Design models all feature very low P11D values, generous standard specification with a choice of high tech ecoFLEX engines for great fuel economy and low emissions including the 'whisper diesel' 1.6CDTi (from 88g/km and 85.6mpg combined).

For even more standard specification, step up to our Tech Line range again you are guaranteed low P11D values, plus great standard kit including Sat Nav (in lieu of parking sensors and Winter Pack on Meriva), Bluetooth®, USB connection and digital radio (excluding Meriva).

With Design and Tech Line you can take for granted low Whole Life Costs and low company car driver taxation.

## COMPANY CAR DRIVER FREE\* 3 DAY TEST DRIVE

Our free\* 3 Day Test Drive programme is open to all Company Car Drivers which allows you to choose any model in the current Vauxhall line-up (excluding all VXR models and Commercial Vehicles), with full insurance cover provided, to give you a meaningful length of time to make an informed decision about your next company car.

Click below to book your free\* test drive  
[www.vauxhall3dtd.co.uk](http://www.vauxhall3dtd.co.uk)  
 or call 0330 587 8221\*\*



## BENEFIT IN KIND COMPANY CAR TAXATION†

The car benefit charge will be the car's list price (including VAT, options and accessories fitted, delivery to Retailer and number plates, but excluding Vehicle Excise Duty and new vehicle first registration fee) multiplied by the percentage charge for the CO<sub>2</sub> emissions band in which the car falls (see table opposite). Multiply this figure by your personal income tax rate (20% for Basic Rate, 40% for Higher Rate) to calculate your annual benefit in kind tax liability.

### Example:

**Insignia Tech Line 1.6CDTi (136PS) Start/Stop ecoFLEX 5-door hatchback**  
 (CO<sub>2</sub> emissions 109g/km)

<b>On-the-road RRP</b>	£23925.00
Deduct: Vehicle Excise Duty	(£140.00)
New vehicle first registration fee	(£55.00)
<b>Effective list price</b>	£23730.00
Add: Optional two-coat metallic paint	£555.00

**List price for tax purposes (P11D value)**  
 £24285.00

**Car benefit charge**  
 2017-18 tax year (23%) £5585.00

**Benefit in kind tax liability (2017-18 tax year)**

Basic Rate (20%) tax payer	£1117.00
Higher Rate (40%) tax payer	£2234.00

† = Please note this Price Guide provides taxation information as a guide only. Vauxhall does not provide taxation guidance. Drivers should always take professional advice on their own tax position.

CO <sub>2</sub> emissions in grams per kilometre	Percentage of car's price to be taxed	
	Petrol 2017-18 tax year	Diesel 2017-18 tax year
up to 50	9	12
51-75	13	16
76-94	17	20
95-99	18	21
100-104	19	22
105-109	20	23
110-114	21	24
115-119	22	25
120-124	23	26
125-129	24	27
130-134	25	28
135-139	26	29
140-144	27	30
145-149	28	31
150-154	29	32
155-159	30	33
160-164	31	34
165-169	32	35
170-174	33	36
175-179	34	37
180-184	35	37
185-189	36	37
190 and above	37	37

To calculate your own personal liability a car tax calculator is available at:  
<https://www.vauxhallfleet.co.uk/toolbox>

\*The free 3 Day Test Drive programme is open to Company Car Drivers and excludes fuel and lubricants; congestion charges; parking and speeding fines and the £250 insurance excess (if applicable). It features a wide selection of models from the Vauxhall range (excluding all VXR models and Commercial Vehicles and subject to availability). Drivers must be aged 25 years or over, have held a full driving licence for at least a year and hold a major credit card. You will need to have your driving licence (and proof of identity (i.e. passport) where the driving licence is not a photocard licence) when your car is delivered. While every effort will be made to ensure that at least 3 days are provided for the test drive, this cannot always be guaranteed due to delivery and collection dates and timings. Available for UK Mainland only. Terms and conditions apply. \*\*Telephone lines open Monday-Friday 9.00am to 5.00pm excluding Bank Holidays. Calls may be recorded or monitored for quality and/or training purposes.

## FLEET TOOLBOX

Discover the facts in our online Toolbox for both Company Car Drivers and Fleet Decision Makers. The Fleet Toolbox has a host of useful calculators, comparators, interactive listings and information. Visit the Fleet Toolbox by going to [www.vauxhall-toolbox.co.uk](http://www.vauxhall-toolbox.co.uk)



## ROADTRIP APP

The Vauxhall RoadTrip App is a free app that calculates and logs your mileage expenses for any UK business trips and generates reports to help you complete your mileage claims. Available for both iPhone and Android, visit [www.vauxhall-toolbox.co.uk](http://www.vauxhall-toolbox.co.uk) or visit the iPhone or Android stores and search for Vauxhall RoadTrip to download it to your smartphone or tablet.



## CONTACT VAUXHALL FLEET

Please contact one of our dedicated sales teams who will be happy to help with your particular enquiry.

### Company Car Drivers

Call: 0345 111 2020  
 Email: [company-car@vauxhallinfo.co.uk](mailto:company-car@vauxhallinfo.co.uk)

Telephone lines are open  
 – Monday to Friday 8.00am-9.00pm  
 – Saturday and Sunday 9.00am-6.00pm

### Fleet Decision Makers

Depending on the size of your fleet of vehicles, we have a dedicated team to handle your enquiries. The lines are open Monday to Friday excluding Bank Holidays.

### 1-24 vehicles

Call: 0845 076 2254 (8.30am-5.00pm)  
 Email: [b2bsales@vauxhall.co.uk](mailto:b2bsales@vauxhall.co.uk)

### 25+ vehicles

Call: 0330 587 8222 (8.30am-5.00pm)  
 Email: [vauxhallfleet@vauxhall.co.uk](mailto:vauxhallfleet@vauxhall.co.uk)

### Special Vehicles (Police, Fire and Ambulance)

Call: 01582 409999 (8.30am-5.00pm)  
 Email: [vauxhallspecialvehicles@vauxhall.co.uk](mailto:vauxhallspecialvehicles@vauxhall.co.uk)

# INSIGNIA CUSTOMER OFFERS

---

At Vauxhall we know that customers appreciate flexibility. Not only do we have an extensive range of Insignia models to choose from, but we have a range of ways to purchase too. Here's an example of our personal contract hire:



---

For ONLY **£287**  
per month over  
35 months with £3,157  
advance rental

---

For even more great deals contact your local Retailer or call 0345 600 1500

**TERMS AND CONDITIONS:** Personal contract hire offer on Insignia SRi Nav 1.4i Turbo (140PS), including free of charge metallic paint, on vehicles ordered by 3 July 2017, subject to availability and status. Age 18+ only. Figures based on a non-maintenance contract hire package with advance rental of £3,157, then 35 monthly rentals of £287. Excess miles over contracted mileage of 24,000 over 36 months charged at 13.16 pence per mile. Excess charges also apply if you breach manufacturer servicing or maintenance guidelines or if the car exceeds BVRLA Fair Wear & Tear guidelines for its age/mileage when it is returned to Vauxhall Leasing. Package includes Road Fund Licence and Vauxhall Assistance. Guarantee/indemnity may be required. Prices and details are subject to change without notice. For full specification and Ts&Cs contact your local Retailer. **You will not own the car.** ALD Automotive Ltd., trading as Vauxhall Leasing, BS16 7LB. Authorised and regulated by the Financial Conduct Authority.

# INSIGNIA RANGE HIGHLIGHTS

## DESIGN

**£18,750-£25,130**

- Digital radio
- Bluetooth® connectivity
- USB connection and aux-in socket
- CD/MP3 CD player/stereo radio (R400 Colour)
- LED daytime running lights
- 17-inch Structure wheels with 225/55 R 17 tyres
- Emergency tyre inflation kit (in lieu of spare wheel)
- Tyre pressure monitoring system
- Leather-covered steering wheel
- Cruise control
- Trip computer
- Electric four-way lumbar adjustment on driver's seat
- Electric height-adjustable driver's seat
- Remote control security alarm
- Remote control central deadlocking
- Six airbags
- Electronic Stability Programme (ESP)
- Electronic climate control
- Electric parking brake
- Automatic lighting control
- Electrically operated front windows
- Electrically adjustable/heated door mirrors
- Steering column adjustable for reach and rake
- Visible single exhaust tailpipe (2.0CDTi 170PS manual models only)

## LIMITED EDITION

**£23,555-£29,825**

### Features over Design

- Vauxhall OnStar
- 18-inch bi-colour alloy wheels with 245/45 R 18 tyres
- Body-colour front spoiler, side sills, rear lip spoiler (not available on Sports Tourer) and rear lower skirt
- VX-Line leather-covered electrically heated sports steering wheel
- VX-Line leather-covered gear knob (manual models only)
- Sports pedals
- Electrically heated sports front seats
- Front and rear parking distance sensors
- Front fog lights
- High-pressure headlight washers
- Visible single exhaust tailpipe

## SRI

**£20,550-£26,430**

### Features over Design

- 17-inch 7-spoke alloy wheels with 225/55 R 17 tyres
- Lowered and uprated sports suspension
- Lowered and modified suspension (ecoFLEX models only)
- Sports pedals (excluding ecoFLEX models)
- Leather-covered sports steering wheel (excluding ecoFLEX models)
- Driver's ergonomic sports seat with extendable seat cushion
- Front fog lights
- Electrically operated rear windows
- Dark-tinted rear windows

## SRI VX-LINE

**£24,610-£27,650**

### Features over SRI

- 19-inch atomic alloy wheels with 245/40 R 19 tyres
- Body-colour front spoiler, side sills, rear lip spoiler (hatchback) and rear lower skirt
- VX-Line leather-covered sports steering wheel
- VX-Line leather-covered gear knob (manual models only)
- Visible single exhaust tailpipe (excluding 2.0i Turbo)
- Visible dual branch exhaust tailpipes (2.0i Turbo)

## SE

**£21,305-£26,080**

### Features over Design

- 17-inch 7-spoke alloy wheels with 225/55 R 17 tyres
- Electrically operated rear windows
- Rain-sensitive windscreen wipers
- Automatic lighting control with tunnel detection
- Anti-dazzle rear-view mirror
- Chrome-effect side window surround

## TECH LINE

**£22,155-£27,755**

### Features over Design

- Navi 900 IntelliLink
- 17-inch 7-spoke alloy wheels with 225/55 R 17 tyres
- Anti-dazzle rear-view mirror
- Automatic lighting control with tunnel detection
- Rain-sensitive windscreen wipers
- Electrically operated rear windows
- Chrome-effect side window surround

## ELITE

**£25,725-£30,385**

### Features over SE

- Vauxhall OnStar
- Dual-zone electronic climate control
- 18-inch 10-spoke alloy wheels with 245/45 R 18 tyres (excluding Sports Tourer 1.6CDTi (136PS) automatic)
- 17-inch 7-spoke alloy wheels with 225/55 R 17 tyres (Sports Tourer 1.6CDTi (136PS) automatic models only)
- Front and rear parking distance sensors
- Front fog lights
- Intelligent AFL with high-pressure headlight washers
- Leather trim with heated front seats
- Eight-way electrically adjustable driver's seat with memory
- Electric height and lumbar adjustment for front passenger's seat
- Electrically foldable door mirrors
- Dark-tinted rear windows (Sports Tourer)

# INSIGNIA HATCHBACK PRICES\*

Model 5-door hatchback	Price (£)	VAT (£)	Total (£)	On-the-road RRP (£)	CO <sub>2</sub> (g/km)	Model 5-door hatchback	Price (£)	VAT (£)	Total (£)	On-the-road RRP (£)	CO <sub>2</sub> (g/km)
<b>DESIGN</b>						<b>SRi</b>					
1.8i (140PS)	14579.17	2915.83	17495.00	<b>18750.00</b>	169	1.8i (140PS)	16079.17	3215.83	19295.00	<b>20550.00</b>	169
1.4i Turbo (140PS) S/S	15491.67	3098.33	18590.00	<b>19505.00</b>	124	1.4i Turbo (140PS) S/S	16991.67	3398.33	20390.00	<b>21305.00</b>	129
<i>Diesel</i>						<i>Diesel</i>					
1.6CDTi (136PS) S/S ecoFLEX	16983.33	3396.67	20380.00	<b>21275.00</b>	109	1.6CDTi (136PS) S/S ecoFLEX	18483.33	3696.67	22180.00	<b>23075.00</b>	109
1.6CDTi (136PS) auto	18354.17	3670.83	22025.00	<b>22980.00</b>	133	1.6CDTi (136PS) S/S	18483.33	3696.67	22180.00	<b>23095.00</b>	116
2.0CDTi (170PS) S/S ecoFLEX BlueInjection**	17650.00	3530.00	21180.00	<b>22095.00</b>	114	1.6CDTi (136PS) auto	19854.17	3970.83	23825.00	<b>24780.00</b>	137
2.0CDTi (170PS) auto BlueInjection**	19020.83	3804.17	22825.00	<b>23780.00</b>	143	2.0CDTi (170PS) S/S ecoFLEX BlueInjection**	19150.00	3830.00	22980.00	<b>23895.00</b>	114
<b>DESIGN NAV†</b>						2.0CDTi (170PS) S/S BlueInjection**					
1.8i (140PS)	15287.50	3057.50	18345.00	<b>19600.00</b>	169	2.0CDTi (170PS) auto BlueInjection**	20520.83	4104.17	24625.00	<b>25580.00</b>	147
1.4i Turbo (140PS) S/S	16200.00	3240.00	19440.00	<b>20355.00</b>	124	<b>SRi NAV†</b>					
<i>Diesel</i>						1.8i (140PS)					
1.6CDTi (136PS) S/S ecoFLEX	17691.67	3538.33	21230.00	<b>22125.00</b>	109	1.4i Turbo (140PS) S/S	17700.00	3540.00	21240.00	<b>22155.00</b>	129
1.6CDTi (136PS) auto	19062.50	3812.50	22875.00	<b>23830.00</b>	133	<i>Diesel</i>					
2.0CDTi (170PS) S/S ecoFLEX BlueInjection**	18358.33	3671.67	22030.00	<b>22945.00</b>	114	1.6CDTi (136PS) S/S ecoFLEX	19191.67	3838.33	23030.00	<b>23925.00</b>	109
2.0CDTi (170PS) auto BlueInjection**	19729.17	3945.83	23675.00	<b>24630.00</b>	143	1.6CDTi (136PS) S/S	19191.67	3838.33	23030.00	<b>23945.00</b>	116
<b>LIMITED EDITION VAUXHALL OnStar</b>						1.6CDTi (136PS) auto					
1.8i (140PS)	18583.33	3716.67	22300.00	<b>23555.00</b>	169	2.0CDTi (170PS) S/S ecoFLEX BlueInjection**	20562.50	4112.50	24675.00	<b>25630.00</b>	137
1.4i Turbo (140PS) S/S	19495.83	3899.17	23395.00	<b>24310.00</b>	129	2.0CDTi (170PS) S/S BlueInjection**	19858.33	3971.67	23830.00	<b>24745.00</b>	118
<i>Diesel</i>						2.0CDTi (170PS) auto BlueInjection**					
1.6CDTi (136PS) S/S ecoFLEX	20916.67	4183.33	25100.00	<b>26015.00</b>	113	Please note: On-the-road recommended retail prices (RRP) include number plates and delivery to Retailer of £700.00 (inc. £116.67 VAT), 12 months' Vehicle Excise Duty and new vehicle first registration fee of £55.00. Excludes fuel and insurance.					
1.6CDTi (136PS) auto	22287.50	4457.50	26745.00	<b>27700.00</b>	137	S/S = Start/Stop.					
2.0CDTi (170PS) S/S ecoFLEX BlueInjection**	21583.33	4316.67	25900.00	<b>26815.00</b>	118	* = Saloon models are available as special order only, please consult your Retailer for details.					
2.0CDTi (170PS) auto BlueInjection**	22954.17	4590.83	27545.00	<b>28500.00</b>	147	** = Please note: Vehicles with BlueInjection technology will need regular AdBlue® top-ups also between servicing requirements. An indicator integrated into the on-board computer will warn you when you need to top up. More information under <a href="http://www.vauxhall.co.uk/blueinjection">www.vauxhall.co.uk/blueinjection</a> . In accordance with regulations R (EC) No. 715/2007 and R (EC) No. 692/2008 (in the versions respectively applicable).					

† = Fitted with Navi 900 IntelliLink satellite navigation system with 8-inch colour touchscreen/stereo radio/CD/MP3 CD player, aux-in, USB sockets/audio streaming/IntelliLink/shark fin aerial.

# INSIGNIA HATCHBACK PRICES\*

Model 5-door hatchback	Price (£)	VAT (£)	Total (£)	On-the-road RRP (£)	CO <sub>2</sub> (g/km)
<b>SRI VX-LINE</b>					
2.0i Turbo (250PS) S/S	19462.50	3892.50	23355.00	<b>24610.00</b>	169
<i>Diesel</i>					
1.6CDTi (136PS) S/S	19500.00	3900.00	23400.00	<b>24315.00</b>	116
1.6CDTi (136PS) auto	20870.83	4174.17	25045.00	<b>26000.00</b>	137
2.0CDTi (170PS) S/S ecoFLEX BlueInjection**	20166.67	4033.33	24200.00	<b>25115.00</b>	118
2.0CDTi (170PS) auto BlueInjection**	21537.50	4307.50	25845.00	<b>26800.00</b>	147
<b>SRI VX-LINE NAV†</b>					
2.0i Turbo (250PS) S/S	20170.83	4034.17	24205.00	<b>25460.00</b>	169
<i>Diesel</i>					
1.6CDTi (136PS) S/S	20208.33	4041.67	24250.00	<b>25165.00</b>	116
1.6CDTi (136PS) auto	21579.17	4315.83	25895.00	<b>26850.00</b>	137
2.0CDTi (170PS) S/S ecoFLEX BlueInjection**	20875.00	4175.00	25050.00	<b>25965.00</b>	118
2.0CDTi (170PS) auto BlueInjection**	22245.83	4449.17	26695.00	<b>27650.00</b>	147
<b>SE</b>					
1.4i Turbo (140PS) S/S	16991.67	3398.33	20390.00	<b>21305.00</b>	124
<i>Diesel</i>					
1.6CDTi (136PS) S/S ecoFLEX	18483.33	3696.67	22180.00	<b>23075.00</b>	109
1.6CDTi (136PS) auto	19854.17	3970.83	23825.00	<b>24780.00</b>	133
2.0CDTi (170PS) S/S ecoFLEX BlueInjection**	19150.00	3830.00	22980.00	<b>23895.00</b>	114
2.0CDTi (170PS) auto BlueInjection**	20520.83	4104.17	24625.00	<b>25580.00</b>	143
<b>TECH LINE†</b>					
1.4i Turbo (140PS) S/S	17700.00	3540.00	21240.00	<b>22155.00</b>	124
<i>Diesel</i>					
1.6CDTi (136PS) S/S ecoFLEX	19191.67	3838.33	23030.00	<b>23925.00</b>	109
1.6CDTi (136PS) auto	20562.50	4112.50	24675.00	<b>25630.00</b>	133
2.0CDTi (170PS) S/S ecoFLEX BlueInjection**	19858.33	3971.67	23830.00	<b>24745.00</b>	114
2.0CDTi (170PS) auto BlueInjection**	21229.17	4245.83	25475.00	<b>26430.00</b>	143

Model 5-door hatchback	Price (£)	VAT (£)	Total (£)	On-the-road RRP (£)	CO <sub>2</sub> (g/km)
<b>ELITE VAUXHALL OnStar</b>					
<i>Diesel</i>					
1.6CDTi (136PS) S/S ecoFLEX	20675.00	4135.00	24810.00	<b>25725.00</b>	113
1.6CDTi (136PS) auto	22045.83	4409.17	26455.00	<b>27410.00</b>	137
2.0CDTi (170PS) S/S ecoFLEX BlueInjection**	21341.67	4268.33	25610.00	<b>26525.00</b>	118
<b>ELITE NAV VAUXHALL OnStar†</b>					
<i>Diesel</i>					
1.6CDTi (136PS) S/S ecoFLEX	21383.33	4276.67	25660.00	<b>26575.00</b>	113
1.6CDTi (136PS) auto	22754.17	4550.83	27305.00	<b>28260.00</b>	137
2.0CDTi (170PS) S/S ecoFLEX BlueInjection**	22050.00	4410.00	26460.00	<b>27375.00</b>	118

**Please note:** On-the-road recommended retail prices (RRP) include number plates and delivery to Retailer of £700.00 (inc. £116.67 VAT), 12 months' Vehicle Excise Duty and new vehicle first registration fee of £55.00. Excludes fuel and insurance.

S/S = Start/Stop.

\* = Saloon models are available as special order only, please consult your Retailer for details.

\*\* = Please note: Vehicles with BlueInjection technology will need regular AdBlue® top-ups also between servicing requirements. An indicator integrated into the on-board computer will warn you when you need to top up. More information under [www.vauxhall.co.uk/blueinjection](http://www.vauxhall.co.uk/blueinjection).

In accordance with regulations R (EC) No. 715/2007 and R (EC) No. 692/2008 (in the versions respectively applicable).

† = Fitted with Navi 900 IntelliLink satellite navigation system with 8-inch colour touchscreen/stereo radio/CD/MP3 CD player, aux-in, USB sockets/audio streaming/IntelliLink/shark fin aerial.



# INSIGNIA SPORTS TOURER PRICES

Model Sports Tourer	Price (£)	VAT (£)	Total (£)	On-the-road RRP (£)	CO <sub>2</sub> (g/km)	Model Sports Tourer	Price (£)	VAT (£)	Total (£)	On-the-road RRP (£)	CO <sub>2</sub> (g/km)
<b>DESIGN</b>						<b>SRI VX-LINE</b>					
1.4i Turbo (140PS) S/S	16579.17	3315.83	19895.00	<b>20850.00</b>	131	2.0i Turbo (250PS) S/S	20545.83	4109.17	24655.00	<b>26210.00</b>	174
<i>Diesel</i>						<i>Diesel</i>					
1.6CDTi (136PS) S/S ecoFLEX	18066.67	3613.33	21680.00	<b>22595.00</b>	114	1.6CDTi (136PS) S/S	20583.33	4116.67	24700.00	<b>25615.00</b>	121
1.6CDTi (136PS) auto	19437.50	3887.50	23325.00	<b>24280.00</b>	138	2.0CDTi (170PS) S/S BlueInjection*	21250.00	4250.00	25500.00	<b>26415.00</b>	124
2.0CDTi (170PS) S/S ecoFLEX BlueInjection*	18733.33	3746.67	22480.00	<b>23395.00</b>	119	<b>SRI VX-LINE NAV**</b>					
<b>DESIGN NAV**</b>						2.0i Turbo (250PS) S/S	21254.17	4250.83	25505.00	<b>27060.00</b>	174
1.4i Turbo (140PS) S/S	17287.50	3457.50	20745.00	<b>21700.00</b>	131	<i>Diesel</i>					
<i>Diesel</i>						1.6CDTi (136PS) S/S	21291.67	4258.33	25550.00	<b>26465.00</b>	121
1.6CDTi (136PS) S/S ecoFLEX	18775.00	3755.00	22530.00	<b>23445.00</b>	114	2.0CDTi (170PS) S/S BlueInjection*	21958.33	4391.67	26350.00	<b>27265.00</b>	124
1.6CDTi (136PS) auto	20145.83	4029.17	24175.00	<b>25130.00</b>	138	<b>SE</b>					
2.0CDTi (170PS) S/S ecoFLEX BlueInjection*	19441.67	3888.33	23330.00	<b>24245.00</b>	119	<i>Diesel</i>					
<b>LIMITED EDITION VAUXHALL OnStar</b>						1.6CDTi (136PS) S/S ecoFLEX	19566.67	3913.33	23480.00	<b>24395.00</b>	114
<i>Diesel</i>						1.6CDTi (136PS) auto	20937.50	4187.50	25125.00	<b>26080.00</b>	138
1.6CDTi (136PS) S/S ecoFLEX	22000.00	4400.00	26400.00	<b>27315.00</b>	118	<b>TECH LINE**</b>					
2.0CDTi (170PS) S/S BlueInjection*	22666.67	4533.33	27200.00	<b>28115.00</b>	124	<i>Diesel</i>					
2.0CDTi (170PS) auto BlueInjection*	24058.33	4811.67	28870.00	<b>29825.00</b>	149	1.6CDTi (136PS) S/S ecoFLEX	20275.00	4055.00	24330.00	<b>25245.00</b>	114
<b>SRI</b>						1.6CDTi (136PS) auto	21645.83	4329.17	25975.00	<b>26930.00</b>	138
<i>Diesel</i>						2.0CDTi (170PS) S/S ecoFLEX BlueInjection*	20941.67	4188.33	25130.00	<b>26045.00</b>	119
1.6CDTi (136PS) S/S ecoFLEX	19566.67	3913.33	23480.00	<b>24395.00</b>	114	2.0CDTi (170PS) auto BlueInjection*	22333.33	4466.67	26800.00	<b>27755.00</b>	145
1.6CDTi (136PS) S/S	19566.67	3913.33	23480.00	<b>24395.00</b>	121	<b>ELITE VAUXHALL OnStar</b>					
2.0CDTi (170PS) S/S ecoFLEX BlueInjection*	20233.33	4046.67	24280.00	<b>25195.00</b>	119	<i>Diesel</i>					
2.0CDTi (170PS) S/S BlueInjection*	20233.33	4046.67	24280.00	<b>25195.00</b>	124	1.6CDTi (136PS) S/S ecoFLEX	21758.33	4351.67	26110.00	<b>27025.00</b>	118
<b>SRI NAV**</b>						1.6CDTi (136PS) auto	23129.17	4625.83	27755.00	<b>28710.00</b>	138
<i>Diesel</i>						2.0CDTi (170PS) S/S BlueInjection*	22425.00	4485.00	26910.00	<b>27825.00</b>	124
1.6CDTi (136PS) S/S ecoFLEX	20275.00	4055.00	24330.00	<b>25245.00</b>	114	2.0CDTi (170PS) auto BlueInjection*	23816.67	4763.33	28580.00	<b>29535.00</b>	149
1.6CDTi (136PS) S/S	20275.00	4055.00	24330.00	<b>25245.00</b>	121	<b>ELITE NAV VAUXHALL OnStar**</b>					
2.0CDTi (170PS) S/S ecoFLEX BlueInjection*	20941.67	4188.33	25130.00	<b>26045.00</b>	119	<i>Diesel</i>					
2.0CDTi (170PS) S/S BlueInjection*	20941.67	4188.33	25130.00	<b>26045.00</b>	124	1.6CDTi (136PS) S/S ecoFLEX	22466.67	4493.33	26960.00	<b>27875.00</b>	118
						1.6CDTi (136PS) auto	23837.50	4767.50	28605.00	<b>29560.00</b>	138
						2.0CDTi (170PS) S/S BlueInjection*	23133.33	4626.67	27760.00	<b>28675.00</b>	124
						2.0CDTi (170PS) auto BlueInjection*	24525.00	4905.00	29430.00	<b>30385.00</b>	149

**Please note:** On-the-road recommended retail prices (RRP) include number plates and delivery to Retailer of £700.00 (inc. £116.67 VAT), 12 months' Vehicle Excise Duty and new vehicle first registration fee of £55.00. Excludes fuel and insurance.

S/S = Start/Stop.

\* = Please note: Vehicles with BlueInjection technology will need regular AdBlue® top-ups also between servicing requirements. An indicator integrated into the on-board computer will warn you when you need to top up. More information under [www.vauxhall.co.uk/blueinjection](http://www.vauxhall.co.uk/blueinjection). In accordance with regulations R (EC) No. 715/2007 and R (EC) No. 692/2008 (in the versions respectively applicable).

\*\* = Fitted with Navi 900 IntelliLink satellite navigation system with 8-inch colour touchscreen/stereo radio/CD/MP3 CD player, aux-in, USB sockets/audio streaming/IntelliLink/shark fin aerial.

# INSIGNIA HATCHBACK PRICES pre-current model year vehicles\*

Model 5-door hatchback	Price (£)	VAT (£)	Total (£)	On-the-road RRP (£)	CO <sub>2</sub> (g/km)
<b>SRI</b>					
<i>Diesel</i>					
1.6CDTi (136PS) S/S ecoFLEX	18483.33	3696.67	22180.00	<b>23055.00</b>	99
<b>SRI NAV**</b>					
1.4i Turbo (140PS) S/S	17700.00	3540.00	21240.00	<b>22155.00</b>	129
<i>Diesel</i>					
1.6CDTi (136PS) S/S ecoFLEX	19191.67	3838.33	23030.00	<b>23905.00</b>	99
2.0CDTi (170PS) S/S BlueInjection	19858.33	3971.67	23830.00	<b>24745.00</b>	118
<b>SRI VX-LINE</b>					
<i>Diesel</i>					
2.0CDTi (170PS) S/S ecoFLEX BlueInjection	20166.67	4033.33	24200.00	<b>25115.00</b>	118
<b>SRI VX-LINE NAV**</b>					
<i>Diesel</i>					
2.0CDTi (170PS) S/S ecoFLEX BlueInjection	20875.00	4175.00	25050.00	<b>25965.00</b>	118
<b>TECH LINE**</b>					
<i>Diesel</i>					
1.6CDTi (136PS) S/S ecoFLEX	19191.67	3838.33	23030.00	<b>23905.00</b>	99

**Please note:** On-the-road recommended retail prices (RRP) include number plates and delivery to Retailer of £700.00 (inc. £116.67 VAT), 12 months' Vehicle Excise Duty and new vehicle first registration fee of £55.00. Excludes fuel and insurance.

S/S = Start/Stop.

\*\* = Fitted with Navi 900 IntelliLink satellite navigation system with 8-inch colour touchscreen/stereo radio/CD/MP3 CD player, aux-in, USB socket/audio streaming/IntelliLink/shark fin aerial.

## PERFORMANCE, FUEL ECONOMY AND EMISSIONS – HATCHBACK MODELS

	Wheel size (inches)	Performance (manufacturer's figures)		Fuel economy mpg (litres/100km)#			CO <sub>2</sub> emissions g/km#	Vehicle Excise Duty†		Benefit in kind company car taxation rates – 2017/18 tax year
		Maximum speed (mph)	Acceleration 0-62mph (sec)	Urban driving	Extra-urban driving	Combined figure		First year rate	Standard rate	
<b>Manual</b>										
1.4i Turbo (140PS) S/S	17/18/19/20	127	10.9	39.2 (7.2)	62.8 (4.5)	51.4 (5.5)	129	£160	£140	24%
1.6CDTi (136PS) S/S ecoFLEX	17	130	10.9	62.8 (4.5)	85.6 (3.3)	74.3 (3.8)	99	£120	£140	21%
1.6CDTi (136PS) S/S ecoFLEX	18/19/20	130	10.9	60.1 (4.7)	80.7 (3.5)	72.4 (3.9)	104	£140	£140	22%
2.0CDTi (170PS) S/S ecoFLEX	18/19/20	139	9.4	50.4 (5.6)	74.3 (3.8)	62.8 (4.5)	118	£160	£140	25%
2.0CDTi (170PS) S/S	17/18/19/20	139	9.4	50.4 (5.6)	74.3 (3.8)	62.8 (4.5)	118	£160	£140	25%

† = Correct at time of publication. S/S = Start/Stop.

# = Fuel consumption information is official government environmental data, tested in accordance with the relevant EU directive. Official EU-regulated test data is provided for comparison purposes and actual performance will depend on driving style, road conditions and other non-technical factors.

\* = Please note that vehicles are limited from stock and that specifications may differ from those described in this Price Guide – consult your Retailer for further details.



# INSIGNIA SPORTS TOURER PRICES pre-current model year vehicles\*

Model Sports Tourer	Price (£)	VAT (£)	Total (£)	On-the-road RRP (£)	CO <sub>2</sub> (g/km)
<b>SRi NAV**</b>					
<i>Diesel</i>					
1.6CDTi (136PS) S/S ecoFLEX	20275.00	4055.00	24330.00	<b>25225.00</b>	104
<b>TECH LINE**</b>					
<i>Diesel</i>					
1.6CDTi (136PS) S/S ecoFLEX	20275.00	4055.00	24330.00	<b>25225.00</b>	104
<b>ELITE NAV**</b>					
<i>Diesel</i>					
2.0CDTi (170PS) auto BlueInjection	24525.00	4905.00	29430.00	<b>30385.00</b>	149

Please note: On-the-road recommended retail prices (RRP) include number plates and delivery to Retailer of £700.00 (inc. £116.67 VAT), 12 months' Vehicle Excise Duty and new vehicle first registration fee of £55.00. Excludes fuel and insurance.

S/S = Start/Stop.

\*\* = Fitted with Navi 900 IntelliLink satellite navigation system with 8-inch colour touchscreen/stereo radio/CD/MP3 CD player, aux-in, USB socket/audio streaming/IntelliLink/shark fin aerial.

## PERFORMANCE, FUEL ECONOMY AND EMISSIONS – SPORTS TOURER MODELS

	Wheel size (inches)	Performance (manufacturer's figures)		Fuel economy mpg (litres/100km)#			CO <sub>2</sub> emissions g/km#	Vehicle Excise Duty†		Benefit in kind company car taxation rates – 2017/17 tax year
		Maximum speed (mph)	Acceleration 0-62mph (sec)	Urban driving	Extra-urban driving	Combined figure		First year rate	Standard rate	
<b>Manual</b>										
1.6CDTi (136PS) S/S ecoFLEX	17	127	11.4	61.4 (4.6)	78.5 (3.6)	72.4 (3.9)	104	£140	£140	22%
1.6CDTi (136PS) S/S ecoFLEX	18/19/20	127	11.4	58.9 (4.8)	76.3 (3.7)	68.9 (4.1)	109	£140	£140	23%
<b>Automatic</b>										
2.0CDTi (170PS)	17/18/19/20	134	9.9	36.2 (7.8)	64.2 (4.4)	49.6 (5.7)	149	£200	£140	31%

† = Correct at time of publication. S/S = Start/Stop.

# = Fuel consumption information is official government environmental data, tested in accordance with the relevant EU directive. Official EU-regulated test data is provided for comparison purposes and actual performance will depend on driving style, road conditions and other non-technical factors.

\* = Please note that vehicles are limited from stock and that specifications may differ from those described in this Price Guide – consult your Retailer for further details.

# INSIGNIA FEATURES/OPTIONS

## SAFETY

### Standard features

**Airbags:** • Driver's dual-stage airbag • Front passenger's dual-stage airbag • Front seat side-impact airbags • Full-size curtain airbags • Deactivation switch for front passenger's airbags

**Seating:** • Height-adjustable head restraints on outer rear seats • Five lap and diagonal inertia-reel seatbelts (height-adjustable front) • Front body-lock diagonal seatbelt pretensioner system • Driver's lap belt pretensioner system • Front seatbelt force limiters • Anti-submarining ramps in front seats • ISOFIX child seat restraint system for all rear seats incorporating top tether (does not include child seat)

**Electronic:** • Electronic Stability Programme-plus (ESP-plus) • Anti-lock Braking System (ABS) • Cornering brake control • Emergency brake assist • Straight line stability control • Traction control • Adaptive brake lights • Electric parking brake • Hill start assist (manual models only) • Tyre pressure monitoring system

**Body:** • Energy-absorbing steering column • Pedal release system • Laminated windscreen • Side-impact protection beams • Reinforced passenger safety cell • Deformation zones front and rear • Burst-proof door locks and anti-jam door design

**Pedestrian:** • Multi-pivot bonnet hinges • Low density foam near front bumper crossmember • Plastic lower front bumper stiffener

	Design	Limited Edition	SRI	SRI VX-Line	SE	Tech Line	Elite	Price (£) exc. VAT	Total (£) inc. VAT
<b>Additional features</b>									
Active-safety front seat head restraints			●	●					
Height-adjustable centre rear seat head restraint	□	□	□	□	□	□	●		
<b>Park and Go Technology Pack</b> <sup>1</sup> • Side blind spot alert • Lane change alert • Rear crossing traffic alert	○	○	○	○	○	○	○	425.00	<b>510.00</b>

## SECURITY

**Standard features** • Remote control security alarm system • Remote control central deadlocking (doors/tailgate, fuel flap) • Visible Vehicle Identification Number (VIN) plate • 'Key left in ignition' audible warning • Electronic engine deadlock immobiliser • Door-to-door illumination • Foldable key • Driver's internal central locking switch

	Design	Limited Edition	SRI	SRI VX-Line	SE	Tech Line	Elite	Price (£) exc. VAT	Total (£) inc. VAT
<b>Additional features</b>									
Locking wheel nuts for alloy wheels (where fitted)	●	●	●	●	●	●	●		
Keyless entry and start	○	○	○	○	○	○	○	337.50	<b>405.00</b>

## HEATING AND VENTILATION

**Standard features** • Air blend heater • Side window demist vents and adjustable face-level air vents • Air recirculation system with activation light • Interior pollen filter • Rear passenger compartment heating ducts

	Design	Limited Edition	SRI	SRI VX-Line	SE	Tech Line	Elite	Price (£) exc. VAT	Total (£) inc. VAT
<b>Additional features</b>									
Single-zone electronic climate control incorporating air conditioning	●	●	●	●	●	●			
Dual-zone electronic climate control incorporating air conditioning with variable side-to-side temperature settings, multi-zone sun sensor and humidity sensor	□	□	□	□	○	○	●	337.50	<b>405.00</b>
<b>Premium Sensory Pack</b> • Dual-zone electronic climate control incorporating air conditioning • Tunnel detection for automatic lighting control • Rain-sensitive windscreen wipers • Electro-chromatic anti-dazzle rear-view mirror	○	○	○	○			●	429.17	<b>515.00</b>

● = Standard equipment. ○ = Optional at extra cost. □ = Available as part of an extra-cost option pack.

<sup>1</sup> = Only available in conjunction with rear-view camera.

# INSIGNIA FEATURES/OPTIONS

## AUDIO, COMMUNICATION AND NAVIGATION

	Design	Limited Edition	SRI	SRI VX-Line	SE	Tech Line	Elite	Price (£) exc. VAT	Total (£) inc. VAT
<b>R400 Colour</b> • CD/MP3 CD player • AM/FM stereo radio with 25 station presets • USB connection and aux-in socket • 4.2-inch colour monitor • RDS with Traffic Programme • 20 watts per channel output • 6 speakers • Roof-mounted flexible aerial	●	●	●	●	●		●		
<b>Touch R700 IntelliLink</b> • CD/MP3 CD player • AM/FM stereo radio • 60 configurable favourites including phone contacts, addresses, playlists and radio stations • USB connection and aux-in socket • Audio streaming • IntelliLink • 8-inch colour touchscreen display • RDS with Traffic Programme • 20 watts per channel output • 7 speakers • Shark fin aerial (not with Vauxhall OnStar)	○	○	○	○	○		○	300.00	<b>360.00</b>
<b>Navi 900 IntelliLink</b> • Satellite navigation system • CD/MP3 CD player • AM/FM stereo radio • 60 configurable favourites including phone contacts, addresses, playlists and radio stations • USB connection and aux-in socket • Audio streaming • IntelliLink • 8-inch colour touchscreen display • RDS with Traffic Programme • 20 watts per channel output • 7 speakers • Shark fin aerial	▲	○	▲	▲	○	●	▲	1008.33	<b>1210.00</b>
Vauxhall OnStar <sup>2</sup>	○	●	○	○	○	○	●	337.50	<b>405.00</b>
Steering wheel mounted audio controls	●	●	●	●	●	●	●		
Bluetooth® connectivity	●	●	●	●	●	●	●		
Digital radio	●	●	●	●	●	●	●		
<b>BOSE® Premium Sound System<sup>3</sup></b> • 4x45w channels • Bose® digital amplifier with six channels of customised equalisation • 7 premium speakers • Subwoofer	○	○	○	○	○	○	○	445.83	<b>535.00</b>

● = Standard equipment. ○ = Optional at extra cost. ▲ = See price pages for details.

<sup>2</sup> = Includes 12 months of OnStar services from date of first registration and a 3 month/3 GB Wi-Fi free trial period (whichever comes first) effective from the date the customer accepts the nominated network operator Wi-Fi Ts&Cs. Destination download feature only operates on models fitted with Navi 900 IntelliLink navigation system. <sup>3</sup> = On hatchback models, luggage capacity is reduced due to a raised (10cm) luggage compartment floor.

### VAUXHALL ONSTAR – YOUR PERSONAL ON BOARD ASSISTANT

Many car brands talk about innovation as soon as they improve their cup holders but this innovative system, now available on selected models\*, is revolutionary: 24/7, 365 days a year, Vauxhall OnStar puts you in touch with a trained advisor, not a machine. With OnStar you have access to a host of innovations, from Vehicle Diagnostics and Smartphone Function to a fully integrated 4G Wi-Fi Hotspot\*\*. In the event of an accident, Vauxhall OnStar even automatically calls for help, for an incomparable feeling of safety.

\* = The OnStar Services require activation and are subject to mobile network coverage and availability. Wi-Fi Hotspot service requires account with nominated network operator.

\*\* = 4G is subject to mobile network coverage and availability. Charges apply after the free trial period. The OnStar subscription packages could be different from the services included in the free trial package. Check [www.vauxhall.co.uk/onstar](http://www.vauxhall.co.uk/onstar) for terms and conditions, details of availability, coverage and charges.

### TOUCH R700 INTELLILINK

Upgrade to the optional Touch R700 IntelliLink and effortlessly connect to your preferred choice of digital media. Using the clear 8-inch colour touchscreen, it's easy to contact clients and colleagues, friends and family – and access all the information you need, on demand. It's also possible to re-configure the optional displays with a choice of 60 personal favourites. This allows you to prioritise icons and select key information on the centre console display – just as you would on a home computer screen. That's everything from your favourite bands to your most listened to radio stations, to phone contacts and music playlists. In addition, Apple iPhone users can project functions using Apple CarPlay as follows:

- Siri voice control
- Basic services including, maps, phone, messaging and music
- Supports third party apps

As you would expect of such an advanced system, Touch R700 also offers video playback and audio streaming via Bluetooth®-enabled devices.

### NAVI 900 INTELLILINK

For easy, hands-free operation, upgrade to Navi 900, with touchscreen and IntelliLink technology. This advanced, interactive sat nav unit understands voice commands for destination input. Additional features include pan-European sat nav menus, video playback and audio streaming via Bluetooth®. Navi 900 IntelliLink is fitted as standard on Tech Line and Nav models.

### 8-INCH DIGITAL COLOUR SCREEN

With Insignia, key information is no longer confined to the centre console. You can read off infotainment, phone and sat nav menus located within the instrument cluster display. The controls themselves are conveniently mounted on the steering wheel. The 8-inch digital colour screen is optional at extra cost on all models fitted with the R700 IntelliLink and Navi 900 IntelliLink system.

### BOSE® SOUND SYSTEM

The optional Bose® sound system delivers unprecedented performance, immersing you and your passengers in high quality surround sound. Features include: 4x45w channels, a six-channel digital amplifier which automatically equalises the sound depending on driving style/conditions, 7 premium speakers and a subwoofer.

# INSIGNIA FEATURES/OPTIONS

## FACIA, INSTRUMENTS AND CONTROLS

**Standard features** • Leather-covered three-spoke steering wheel • Driver information centre incorporating multi-function trip computer • Cruise control with speed limiter function • Rev counter • Coolant temperature gauge • Fuel gauge • Digital clock with automatic RDS time adjustment • Multi-function display showing time, date, audio information and outside air temperature • Steering column adjustable for reach and rake • Electronic odometer and trip odometer • Instrument panel light dimmer

	Design	Limited Edition	SRI	SRI VX-Line	SE	Tech Line	Elite	Price (£) exc. VAT	Total (£) inc. VAT
<b>Additional features</b>									
8-inch digital colour screen speedometer with supplementary audio, phone and navigation information <sup>4</sup>	○	○	○	○	○	○	○	341.67	<b>410.00</b>
Leather-covered three-spoke sports steering wheel <sup>5</sup>			●						
VX-Line leather-covered three-spoke sports steering wheel, leather-covered gear knob (manual models only) and dark headlining		●	□	●			□		
Electrically heated leather-covered steering wheel (only in conjunction with leather seat facings)	○	●	○	○	○	○	○	170.83	<b>205.00</b>
<b>Winter Pack 1<sup>6</sup></b> • Electrically heated front seats • High-pressure headlight washers • Electrically heated leather-covered steering wheel	○	●	○	○	○	○		587.50	<b>705.00</b>
<b>Winter Pack 2<sup>7</sup></b> • Electrically heated front seats • Electrically heated leather-covered steering wheel	○		○	○	○	○		425.00	<b>510.00</b>
<b>Winter Pack 3<sup>8</sup></b> • Electrically heated leather-covered steering wheel • High-pressure headlight washers	○		○	○	○	○		337.50	<b>405.00</b>
Front camera system incorporating traffic sign recognition, lane departure warning, forward collision alert, following distance indicator and heat-reflective windscreen <sup>9</sup>	○	○	○	○	○	○	○	633.33	<b>760.00</b>
Adaptive cruise control incorporating front camera system and automatic brake intervention (includes 'Stop and Go' function on automatic models) <sup>9,10</sup>	○	○	○	○	○	○	○	925.00	<b>1110.00</b>

## INTERIOR AND CONVENIENCE FEATURES

**Standard features** • Storage box on driver's side lower fascia • Lidded glovebox • Front and rear door pockets • Twin sunvisors incorporating illuminated driver's and front passenger's vanity mirrors with covers • 12-volt auxiliary power socket in front centre console • Chrome internal door handles • Hinged luggage compartment cover (hatchback) • Carpeted rear seat back • Fully carpeted luggage area • Retractable luggage compartment cover (Sports Tourer) • Boot/luggage area sill protection • Stainless steel trim on luggage compartment lip (Sports Tourer) • Load restraint lashing eyes • DualFloor luggage compartment (Sports Tourer)

	Design	Limited Edition	SRI	SRI VX-Line	SE	Tech Line	Elite	Price (£) exc. VAT	Total (£) inc. VAT
<b>Additional features</b>									
Trigo Cool inserts on fascia and doors	●	●	● <sup>11</sup>						
Diamo Black inserts on fascia and doors			● <sup>12</sup>	●			● <sup>13</sup>		
Echelon Cool inserts on fascia and doors					●	●	● <sup>14</sup>		
Wood-effect inserts on fascia and doors (with Saddle Up interior trim)					●		●		
Sports pedals		●	● <sup>12</sup>	●			□		
Electro-chromatic anti-dazzle rear-view mirror	□	□	□	□	●	●	●		
<b>FlexOrganiser® Pack</b> (Sports Tourer) • Four side rails • 3D storage net • Side net pocket • Four side rail hooks	○	○	○	○	○	○	○	100.00	<b>120.00</b>

● = Standard equipment. ○ = Optional at extra cost. □ = Available as part of an extra-cost option pack.

<sup>4</sup> = Only available in conjunction with optional IntelliLink audio units. <sup>5</sup> = Sports steering wheel is replaced by a non-perforated leather-covered three-spoke steering wheel on ecoFLEX models or when the optional Winter Packs or electrically heated steering wheel are specified. <sup>6</sup> = Not available in conjunction with leather seat facings or Adaptive Forward Lighting. <sup>7</sup> = Only available in conjunction with Adaptive Forward Lighting. Not available with leather seat facings. <sup>8</sup> = Only available in conjunction with leather seat facings. Not available with Adaptive Forward Lighting. <sup>9</sup> = Only available in conjunction with Sight and Light Pack and either front and rear parking distance sensors or advanced park assist. <sup>10</sup> = Not available on 1.8i or 1.4i Turbo models. <sup>11</sup> = Standard on ecoFLEX models only. <sup>12</sup> = Standard on all models except ecoFLEX models. <sup>13</sup> = Fitted as part of the Premium Nappa Leather Pack. <sup>14</sup> = Fitted with black Siena and perforated Siena interior trim.

# INSIGNIA FEATURES/OPTIONS

## INTERIOR LIGHTING

**Standard features** • Fade up/fade down courtesy lights operated by front and rear door switches • Illuminated luggage area and glovebox • Map reading lights • Front courtesy light • Two rear reading lights  
 • Illuminated driver's and front passenger's footwells • Interior ambient lighting

## SEATING AND UPHOLSTERY

**Standard features** • Driver's seat with electrical four-way lumbar adjustment • Driver's seat with tilt and electrical height adjustment • Front passenger's seat with reach and rake adjustment  
 • Front centre armrest with storage facility • Storage pockets on front seat backs

	Design	Limited Edition	SRi	SRi VX-Line	SE	Tech Line	Elite	Price (£) exc. VAT	Total (£) inc. VAT
<b>Additional features</b>									
Front passenger's seat comfort pack incorporating six-way manual adjustment with electrical height and four-way lumbar adjustment. Also includes lap belt pretensioner system <sup>15</sup>	○	○	○	○	○	○	●	262.50	<b>315.00</b>
Driver's seat with eight-way electrical adjustment and memory function							●		
Sports front seats with ergonomic AGR* driver's seat including extendable seat cushion	○ <sup>16</sup>	●	●	●	○ <sup>16</sup>	○ <sup>16</sup>	□	354.17	<b>425.00</b>
Lyra cloth seat trim	●								
Ribbon cloth seat trim	○ <sup>17</sup>	●	●	●	○ <sup>17</sup>	○ <sup>17</sup>			
Quantum cloth seat trim					●	●			
<b>Sport Seats Leather Pack</b> • Sports front seats, driver's ergonomic AGR*, with extendable seat cushions • Perforated leather seat facings • Electrically heated front seats • Fold-out rear seat centre armrest with load-through facility • Height-adjustable centre rear seat head restraint		○ <sup>18</sup>	○	○				962.50	<b>1155.00</b>
<b>Sport Seats Leather Pack</b> • Sports front seats, driver's ergonomic AGR*, with extendable seat cushions • Perforated leather seat facings • Electrically heated front seats • Fold-out rear seat centre armrest with load-through facility • Height-adjustable centre rear seat head restraint							○	354.17	<b>425.00</b>
<b>Comfort Leather Pack</b> • Leather seat facings • Electrically heated front seats • Fold-out rear seat centre armrest with load-through facility • Height-adjustable centre rear seat head restraint	○ <sup>18</sup>				○	○	●	879.17	<b>1055.00</b>
<b>Premium Nappa Leather Pack</b> • Ergonomic AGR* sports front seats with extendable seat cushions • Nappa leather seat upholstery • Leather-trimmed head restraints, door panels and centre armrest • Electrically heated front seats • VX-Line leather-covered sports steering wheel and, on manual models, gear knob • Sports pedals • Diamo black inserts on fascia and doors • Fold-out rear seat centre armrest with load-through facility			○ <sup>19</sup>	○			○	2558.33	<b>3070.00</b>
Electrically heated front seats	□	●	□	□	□	□	●		

## REAR PASSENGER COMPARTMENT

	Design	Limited Edition	SRi	SRi VX-Line	SE	Tech Line	Elite	Price (£) exc. VAT	Total (£) inc. VAT
<b>Features</b>									
12-volt auxiliary power socket behind front seats	●	●	●	●	●	●	●		
Fold-out rear seat centre armrest with load-through facility	□	□	□	□	□	□	●		
60/40 split-folding rear seat back	●	●	●	●	●	●	●		

● = Standard equipment. ○ = Optional at extra cost. □ = Available as part of an extra-cost option pack. \* = AGR (The Campaign for Healthier Backs) is an independent centre of excellence for ergonomics, based in Germany.

<sup>15</sup> = Models fitted with sports front seats include front passenger's extendable seat cushion. <sup>16</sup> = Ribbon cloth seat trim replaces Lyra cloth on Design models and Quantum cloth on SE/Tech Line models. <sup>17</sup> = Fitted in conjunction with optional sports front seats. Not available separately. <sup>18</sup> = Also includes electrically operated rear windows. <sup>19</sup> = Not available on ecoFLEX models.

# INSIGNIA FEATURES/OPTIONS

## PLUS PACKS

	Design	Limited Edition	SRi	SRi VX-Line	SE	Tech Line	Elite	Price (£) exc. VAT	Total (£) inc. VAT
<b>Design Plus Pack</b> <sup>20,21</sup> • 18-inch alloy wheels with 245/45 R 18 tyres • Front fog lights	○							416.67	<b>500.00</b>
<b>SE Plus Pack</b> <sup>20,21</sup> • 18-inch alloy wheels with 245/45 R 18 tyres • Front fog lights					○			416.67	<b>500.00</b>
<b>Tech Line Plus Pack</b> <sup>20,21</sup> • 18-inch alloy wheels with 245/45 R 18 tyres • Front fog lights						○		416.67	<b>500.00</b>

## EXTERIOR LIGHTING

**Standard features** • LED daytime running lights • Lights-on audible warning • LED centre brake light • LED tail lights (hatchback models feature reflectors on the tailgate, replaced by LED lights when optional adaptive forward lighting is specified)

	Design	Limited Edition	SRi	SRi VX-Line	SE	Tech Line	Elite	Price (£) exc. VAT	Total (£) inc. VAT
<b>Additional features</b>									
Automatic lighting control	●	●	●	●					
Automatic lighting control with tunnel detection	□	□	□	□	●	●	●		
Front fog lights	□	●	●	●	□	□	●		
Electric headlight beam levelling	●	●	●	●	●	●			
High-pressure headlight washers		●					●		
Intelligent Adaptive Forward Lighting (AFL) incorporating bi-xenon headlights with dynamic beam levelling, high beam assist and high-pressure headlight washers <sup>22</sup>	○	○	○	○	○	○	●	750.00	<b>900.00</b>

## EXTERIOR AND CONVENIENCE FEATURES

**Standard features** • Electrically operated front windows with one-touch facility • Twin electrically adjustable/heated door mirrors (wide-angle on driver's side) with automatic timed cut-off • Touch-sensitive tailgate release • Tinted glass • Heated rear window with automatic timed cut-off • Intermittent rear window wash/wipe • Twin gas-assisted tailgate struts

	Design	Limited Edition	SRi	SRi VX-Line	SE	Tech Line	Elite	Price (£) exc. VAT	Total (£) inc. VAT
<b>Additional features</b>									
<b>Sight and Light Pack</b> • Tunnel detection for automatic lighting control • Rain-sensitive windscreen wipers • Electro-chromatic anti-dazzle rear-view mirror	○	○	○	○	●	●	●	200.00	<b>240.00</b>
Electrically foldable door mirrors (electro-chromatic anti-dazzle on driver's side)	○ <sup>23</sup>	○ <sup>23</sup>	○ <sup>23</sup>	○ <sup>23</sup>	○	○	●	158.33	<b>190.00</b>
Electrically operated rear windows with safety autoreverse	○ <sup>24</sup>	○ <sup>24</sup>	●	●	●	●	●	150.00	<b>180.00</b>
Front and rear parking distance sensors	○	●	○	○	○	○	●	383.33	<b>460.00</b>
Advanced park assist with front and rear parking distance sensors <sup>25</sup>	○	○	○	○	○	○	○	425.00	<b>510.00</b>
Rear-view camera (only available with IntelliLink audio units)	○	○	○	○	○	○	○	258.33	<b>310.00</b>
Retractable tow bar with 13-pin socket <sup>26</sup>	○	○	○	○	○	○	○	570.83	<b>685.00</b>
Electrically operated tailgate – Sports Tourer only	○ <sup>27</sup>	○ <sup>27</sup>	○	○	○	○	●	316.67	<b>380.00</b>

● = Standard equipment. ○ = Optional at extra cost. □ = Available as part of an extra-cost option pack.

<sup>20</sup> = Please note optional alloy wheels can affect fuel consumption and CO<sub>2</sub> emissions, resulting in higher Vehicle Excise Duty and Benefit in Kind. See Performance, Fuel and Emissions tables for more information. <sup>21</sup> = Not available on Sports Tourer 1.6CDTi (136PS) automatic models.

<sup>22</sup> = Also includes Sight and Light Pack. On hatchback models the reflectors on the tailgate are replaced by LED lights. <sup>23</sup> = Only available in conjunction with optional Sight and Light Pack, Premium Sensory Pack or Adaptive Forward Lighting. <sup>24</sup> = Fitted in conjunction with optional Leather Pack.

<sup>25</sup> = Not available in conjunction with front and rear parking distance sensors. <sup>26</sup> = Not available on 1.4i Turbo Sports Tourer models. <sup>27</sup> = Only available in conjunction with electrically operated rear windows.

# INSIGNIA FEATURES/OPTIONS

## EXTERIOR STYLING AND PROTECTION

**Standard features** • Chrome-effect upper grille surround • Body-colour door mirrors • Body-colour door handles • White indicators and side repeaters

	Design	Limited Edition	SRi	SRi VX-Line	SE	Tech Line	Elite	Price (£) exc. VAT	Total (£) inc. VAT
<b>Additional features</b>									
Chrome-effect side window surround					●	●	●		
Chrome-effect door handles – fitted in conjunction with optional keyless entry and start, not available separately	○	○	○	○	○	○	○		
Silver-effect roof rails (Sports Tourer only)	●	●	●	●	●	●	●		
Dark-tinted rear windows – hatchback models	○	○	●	●	○	○	○	237.50	<b>285.00</b>
Dark-tinted rear windows – Sports Tourer models	○	○	●	●	○	○	●	237.50	<b>285.00</b>
Body-colour rear lip spoiler (hatchback only)	●	●	●	●	●	●	●		
Visible single exhaust tailpipe (2.0CDTi (170PS) models only)	● <sup>28</sup>	●	● <sup>28</sup>	●	● <sup>28</sup>	● <sup>28</sup>	● <sup>28</sup>		
Visible dual branch exhaust tailpipes (2.0i Turbo)				●					
<b>VXR Styling Pack</b> • Body-colour front spoiler, side sills, rear lip spoiler and rear lower skirt (rear lip spoiler not available on Sports Tourer) • Visible exhaust tailpipe		●	○ <sup>19</sup>	●	○	○	○	708.33	<b>850.00</b>

## FLEXRIDE SYSTEM AVAILABILITY

	Design	Limited Edition	SRi	SRi VX-Line	SE	Tech Line	Elite	Price (£) exc. VAT	Total (£) inc. VAT
1.4i Turbo (140PS)	○	○	○		○	○		666.67	<b>800.00</b>
2.0i Turbo (250PS)				●					
2.0CDTi (170PS)/2.0CDTi (170PS) ecoFLEX	○	○	○	○	○	○	○	666.67	<b>800.00</b>











● = Standard equipment. ○ = Optional at extra cost.

<sup>19</sup> = Not available on ecoFLEX models. <sup>28</sup> = Manual models only.



# INSIGNIA FEATURES/OPTIONS

## EXTERIOR COLOURS





		Design	Limited Edition	SRI	SRI VX-Line	SE	Tech Line	Elite	Price (£) exc. VAT	Total (£) inc. VAT
	<b>Royal Blue</b> • Solid paint	●	●	●	●	●	●	●		
	<b>Lava Red</b> • Brilliant paint • Not available with Saddle Up or Brandy Nappa trim	○	○	○	○	○	○	○	237.50	<b>285.00</b>
	<b>Summit White</b> • Brilliant paint									
	<b>Sovereign Silver</b> • Two-coat metallic paint									
	<b>Flip Chip Silver</b> • Two-coat metallic paint									
	<b>Cosmic Grey</b> • Two-coat metallic paint									
	<b>Mineral Black</b> • Two-coat metallic paint									
	<b>Macadamia</b> • Two-coat pearlescent paint	○	○	○	○	○	○	○	462.50	<b>555.00</b>
	<b>Dark Sea Blue</b> • Two-coat pearlescent paint									
	<b>Emerald Green</b> • Two-coat pearlescent paint									

● = Standard equipment. ○ = Optional at extra cost.

The colours reproduced may vary slightly from the actual paint colour. As a result they should be used as a guide only. Your Vauxhall Retailer has a comprehensive display of our paint samples.

# INSIGNIA FEATURES/OPTIONS

## WHEELS AND TYRES





	Design	Limited Edition	SRI	SRI VX-Line	SE	Tech Line	Elite	Price (£) exc. VAT	Total (£) inc. VAT
<b>Emergency tyre inflation kit (in lieu of spare wheel)</b>	●	●	●	●	●	●	●		
<b>17-inch steel full-size spare wheel (in lieu of emergency tyre inflation kit – reduces luggage capacity)<sup>2</sup></b>	○		○ <sup>29</sup>		○ <sup>29</sup>	○ <sup>29</sup>	○ <sup>29</sup>	91.67	<b>110.00</b>
<b>Emergency spare wheel (in lieu of emergency tyre inflation kit)</b>	○		○ <sup>29</sup>		○ <sup>29</sup>	○ <sup>29</sup>	○ <sup>29</sup>	91.67	<b>110.00</b>
 <b>17-inch structure wheels:<sup>30</sup></b> 225/55 R 17 tyres	●								
 <b>17-inch 7-spoke alloy wheels:<sup>30</sup></b> 225/55 R 17 tyres			●		●	●	● <sup>31</sup>		
 <b>18-inch 10-twinspoke alloy wheels:<sup>20</sup></b> 245/45 R 18 tyres	□ <sup>21</sup>				□ <sup>21</sup>	□ <sup>21</sup>			
 <b>18-inch bi-colour alloy wheels:</b> 245/45 R 18 tyres		●							

● = Standard equipment. ○ = Optional at extra cost. □ = Available as part of an extra-cost option pack.

<sup>2</sup> = On hatchback models, luggage capacity is reduced due to a raised (10cm) luggage compartment floor. <sup>20</sup> = Please note optional alloy wheels can affect fuel consumption and CO<sub>2</sub> emissions, resulting in higher Vehicle Excise Duty and Benefit in Kind. See Performance, Fuel and Emissions tables for more information. <sup>21</sup> = Not available on Sports Tourer 1.6CDTi (136PS) automatic models. <sup>29</sup> = Not available in conjunction with VXR Styling Pack. <sup>30</sup> = Design, SE, Tech Line and SRI ecoFLEX models feature ultra-low rolling resistance tyres. <sup>31</sup> = Standard on Sports Tourer 1.6CDTi (136PS) automatic models only. Not available on other models.

# INSIGNIA FEATURES/OPTIONS

## WHEELS AND TYRES



	Design	Limited Edition	SRI	SRI VX-Line	SE	Tech Line	Elite	Price (£) exc. VAT	Total (£) inc. VAT
 <b>18-inch 10-spoke alloy wheels:</b> 245/45 R 18 tyres							● <sup>21</sup>		
 <b>18-inch 5-twinblade alloy wheels:<sup>20</sup></b> 245/45 R 18 tyres			○ <sup>19</sup>					137.50	<b>165.00</b>
 <b>19-inch atomic alloy wheels:</b> 245/40 R 19 tyres		○		●				433.33	<b>520.00</b>
 <b>19-inch turbine alloy wheels:<sup>20</sup></b> 245/40 R 19 tyres			○ <sup>32</sup>					479.17	<b>575.00</b>
 <b>19-inch turbine alloy wheels:</b> 245/40 R 19 tyres				○				91.67	<b>110.00</b>

● = Standard equipment. ○ = Optional at extra cost.

<sup>19</sup> = Not available on ecoFLEX models. <sup>20</sup> = Please note optional alloy wheels can affect fuel consumption and CO<sub>2</sub> emissions, resulting in higher Vehicle Excise Duty and Benefit in Kind. See Performance, Fuel and Emissions tables for more information. <sup>21</sup> = Not available on Sports Tourer 1.6CDTi (136PS) automatic models. <sup>32</sup> = Not available in conjunction with 17-inch steel spare wheel or 1.6CDTi (136PS) ecoFLEX and 2.0CDTi (170PS) ecoFLEX models.

# INSIGNIA FEATURES/OPTIONS





## WHEELS AND TYRES

	Design	Limited Edition	SRI	SRI VX-Line	SE	Tech Line	Elite	Price (£) exc. VAT	Total (£) inc. VAT
 <b>20-inch bi-colour alloy wheels:</b> <sup>20</sup> 245/35 R 20 tyres			○ <sup>32</sup>	○				733.33	<b>880.00</b>
 <b>19-inch 10-spoke alloy wheels:</b> 245/40 R 19 tyres							○ <sup>33</sup>	391.67	<b>470.00</b>
 <b>20-inch multi-spoke alloy wheels:</b> 245/35 R 20 tyres							○ <sup>33</sup>	733.33	<b>880.00</b>

● = Standard equipment. ○ = Optional at extra cost.

<sup>20</sup> = Please note optional alloy wheels can affect fuel consumption and CO<sub>2</sub> emissions, resulting in higher Vehicle Excise Duty and Benefit in Kind. See Performance, Fuel and Emissions tables for more information. <sup>32</sup> = Not available in conjunction with 17-inch steel spare wheel or 1.6CDTi (136PS) ecoFLEX and 2.0CDTi (170PS) ecoFLEX models. <sup>33</sup> = Not available on Sports Tourer 1.6CDTi (136PS) automatic models, or in conjunction with 17-inch steel spare wheel.

## TYRE RATING

Tyre size	Fuel efficiency group	Wet grip performance	External noise	
			Measured (dB)	Group
225/55 R 17	B-E	B	71	
245/45 R 18	C-E	B	68-76	
245/40 R 19	E	B	68	
245/35 R 20	E	B	71	

Tyre rating according to EU Regulation 1222/2009

# INSIGNIA SPECIFICATIONS

## PETROL ENGINES

	<b>1.8i (140PS) ECOTEC-4</b>	<b>1.4i Turbo (140PS) ECOTEC-4 Start/Stop</b>	<b>2.0i (250PS) ECOTEC-4 Turbo with and without Start/Stop</b>
Capacity	1796cc	1364cc	1998cc
Maximum power	140PS (103kW) @ 6300rpm	140PS (103kW) @ 4900-6000rpm	250PS (184kW) @ 5300rpm
Maximum torque	175Nm (129 lb.ft.) @ 3800rpm	200Nm (147 lb.ft.) @ 1850-4900rpm	400Nm (295 lb.ft.) @ 2500-4000rpm
Configuration	4 cylinders, 4 valves per cylinder, double overhead camshafts	4 cylinders, 4 valves per cylinder, double overhead camshafts	4 cylinders, 4 valves per cylinder, double overhead camshafts
Fuel/induction system	Naturally aspirated Variable Valve Timing (VVT). Multi-point sequential fuel injection	Turbocharger with intercooler. Variable Valve Timing (VVT). Multi-point sequential fuel injection	Twin-scroll turbocharger with intercooler. Direct fuel injection
Emission compliance	Euro 6	Euro 6	Euro 6
Service interval	20,000 miles or 1 year (whichever occurs sooner)	20,000 miles or 1 year (whichever occurs sooner)	20,000 miles or 1 year (whichever occurs sooner)

## TURBO DIESEL ENGINES

	<b>1.6CDTi (136PS) ECOTEC-4 with and without Start/Stop</b>	<b>2.0CDTi (170PS) ECOTEC-4 with and without Start/Stop</b>
Capacity	1598cc	1956cc
Maximum power	136PS (100kW) @ 3500-4000rpm	170PS (125kW) @ 3500-4000rpm
Maximum torque	320Nm (236 lb.ft.) @ 2000rpm	400Nm (295 lb.ft.) @ 1750-2500rpm
Configuration	4 cylinders, 4 valves per cylinder, double overhead camshafts	4 cylinders, 4 valves per cylinder, double overhead camshafts
Fuel/induction system	Variable geometry turbocharger with intercooler. Common rail fuel injection	Variable geometry turbocharger with intercooler. Common rail fuel injection
Emission compliance	Euro 6 with Diesel Particulate Filter	Euro 6 with Diesel Particulate Filter
Service interval	20,000 miles or 1 year (whichever occurs sooner)	20,000 miles or 1 year (whichever occurs sooner)

# INSIGNIA SPECIFICATIONS

## PERFORMANCE, FUEL ECONOMY AND EMISSIONS – HATCHBACK MODELS

	Wheel size (inches)	Performance (manufacturer's figures)		Fuel economy mpg (litres/100km)#			CO <sub>2</sub> emissions g/km#	Vehicle Excise Duty*		Benefit in kind company car taxation rates – 2017/18 tax year
		Maximum speed (mph)	Acceleration 0-62mph (sec)	Urban driving	Extra-urban driving	Combined figure		First year rate	Standard rate	
<b>Manual</b>										
1.8i (140PS)	17/18/19/20	127	11.5	27.4 (10.3)	50.4 (5.6)	38.7 (7.3)	169	£500	£140	32%
1.4i Turbo (140PS) Start/Stop Design/SE/Tech Line	17	127	10.9	40.4 (7.0)	65.7 (4.3)	53.3 (5.3)	124	£160	£140	23%
1.4i Turbo (140PS) Start/Stop SRI	17	127	10.9	39.2 (7.2)	62.8 (4.5)	51.4 (5.5)	129	£160	£140	24%
1.4i Turbo (140PS) Start/Stop	18/19/20	127	10.9	39.2 (7.2)	62.8 (4.5)	51.4 (5.5)	129	£160	£140	24%
2.0i Turbo (250PS) Start/Stop	19/20	155	7.5	29.1 (9.7)	48.7 (5.8)	39.2 (7.2)	169	£500	£140	32%
1.6CDTi (136PS) Start/Stop ecoFLEX Design/SE/Tech Line/SRI**	17	130	10.9	56.5 (5.0)	78.5 (3.6)	68.9 (4.1)	109	£140	£140	23%
1.6CDTi (136PS) Start/Stop ecoFLEX (excluding SRI)**	18/19/20	130	10.9	55.4 (5.1)	74.3 (3.8)	65.7 (4.3)	113	£160	£140	24%
1.6CDTi (136PS) Start/Stop SRI**	17/18/19/20	127	10.9	53.3 (5.3)	72.4 (3.9)	64.2 (4.4)	116	£160	£140	25%
2.0CDTi (170PS) Start/Stop ecoFLEX Design/SE/Tech Line/SRI	17	139	9.4	51.4 (5.5)	78.5 (3.6)	65.7 (4.3)	114	£160	£140	24%
2.0CDTi (170PS) Start/Stop ecoFLEX (excluding SRI)	18/19/20	139	9.4	50.4 (5.6)	74.3 (3.8)	62.8 (4.5)	118	£160	£140	25%
2.0CDTi (170PS) Start/Stop SRI	17/18/19/20	139	9.4	50.4 (5.6)	74.3 (3.8)	62.8 (4.5)	118	£160	£140	25%
<b>Automatic</b>										
1.6CDTi (136PS) Design/SE/Tech Line**	17	124	10.9	42.2 (6.7)	70.6 (4.0)	56.5 (5.0)	133	£200	£140	28%
1.6CDTi (136PS) SRI**	17	124	10.9	41.5 (6.8)	67.3 (4.2)	54.3 (5.2)	137	£200	£140	29%
1.6CDTi (136PS)**	18/19/20	124	10.9	41.5 (6.8)	67.3 (4.2)	54.3 (5.2)	137	£200	£140	29%
2.0CDTi (170PS) Design/SE/Tech Line	17	137	9.4	37.2 (7.6)	68.9 (4.1)	52.3 (5.4)	143	£200	£140	30%
2.0CDTi (170PS)	17/18/19/20	137	9.4	36.2 (7.8)	67.3 (4.2)	50.4 (5.6)	147	£200	£140	31%

## PERFORMANCE, FUEL ECONOMY AND EMISSIONS – SPORTS TOURER MODELS

	Wheel size (inches)	Performance (manufacturer's figures)		Fuel economy mpg (litres/100km)#			CO <sub>2</sub> emissions g/km#	Vehicle Excise Duty*		Benefit in kind company car taxation rates – 2017/18 tax year
		Maximum speed (mph)	Acceleration 0-62mph (sec)	Urban driving	Extra-urban driving	Combined figure		First year rate	Standard rate	
<b>Manual</b>										
1.4i (140PS) Turbo Start/Stop	17	124	11.5	38.7 (7.3)	61.4 (4.6)	50.4 (5.6)	131	£200	£140	25%
1.4i (140PS) Turbo Start/Stop	18	124	11.5	37.7 (7.5)	58.9 (4.8)	48.7 (5.8)	136	£200	£140	26%
2.0i Turbo (250PS) Start/Stop	19/20	152	7.8	28.2 (10.0)	47.9 (5.9)	38.2 (7.4)	174	£800	£140	33%
1.6CDTi (136PS) Start/Stop ecoFLEX Design/SE/Tech Line/SRI**	17	127	11.4	54.3 (5.2)	74.3 (3.8)	65.7 (4.3)	114	£160	£140	24%
1.6CDTi (136PS) Start/Stop ecoFLEX (excluding SRI)**	18/19/20	127	11.4	52.3 (5.4)	72.4 (3.9)	62.8 (4.5)	118	£160	£140	25%
1.6CDTi (136PS) Start/Stop SRI**	17/18/19/20	124	11.4	52.3 (5.4)	68.9 (4.1)	61.4 (4.6)	121	£160	£140	26%
2.0CDTi (170PS) Start/Stop ecoFLEX Design/SE/Tech Line/SRI	17	137	9.9	49.6 (5.7)	74.3 (3.8)	62.8 (4.5)	119	£160	£140	25%
2.0CDTi (170PS) Start/Stop	17/18/19/20	137	9.9	48.7 (5.8)	70.6 (4.0)	60.1 (4.7)	124	£160	£140	26%
<b>Automatic</b>										
1.6CDTi (136PS)**	17	121	11.4	41.5 (6.8)	65.7 (4.3)	54.3 (5.2)	138	£200	£140	29%
2.0CDTi (170PS) Tech Line	17	134	9.9	36.7 (7.7)	67.3 (4.2)	51.4 (5.5)	145	£200	£140	31%
2.0CDTi (170PS)	17/18/19/20	134	9.9	36.2 (7.8)	64.2 (4.4)	49.6 (5.7)	149	£200	£140	31%

\* = Correct at time of publication. \*\* = Fuel economy and emissions data is provisional.

# = Fuel consumption information is official government environmental data, tested in accordance with the relevant EU directive. Official EU-regulated test data is provided for comparison purposes and actual performance will depend on driving style, road conditions and other non-technical factors.

# INSIGNIA SPECIFICATIONS

## WEIGHTS AND TOWING DATA<sup>kg</sup>

	Gross vehicle weight		Max. towing weights Trailer with brakes (without brakes)	
	Hatchback	Sports Tourer	Hatchback	Sports Tourer
1.8i (140PS)	2040	–	1400 (750)	–
1.4i Turbo (140PS)	2065	2140	1250 (730)	1200 (750)
2.0i Turbo (250PS)	2160	2280	1800 (750)	1800 (750)
1.6CDTi (136PS) ecoFLEX	2120	2250	1800 (750)	1700 (750)
1.6CDTi (136PS) automatic	2140	2280	1800 (750)	1700 (750)
2.0CDTi (170PS) ecoFLEX	2180	2310	1800 (750)	1800 (750)
2.0CDTi (170PS) automatic	2210	2320	1800 (750)	1800 (750)

Gross vehicle weight is the total permissible weight of the vehicle including passengers and their luggage. The maximum roof rack loading should not exceed 100kg. The maximum towing weights are based on the ability of the car, with two occupants of 75kg each, to restart on a 12% gradient, which is approximately 1 in 8.3, at sea level. At altitudes above 1500 metres, the engine output may drop with a corresponding reduction in towing capability. Any extra weight, such as luggage or additional passengers, should be deducted from the maximum towing weight. With a trailer fully loaded, maximum noseweight should not exceed 85kg. Always fit Vauxhall towing attachments and accessories available from your Vauxhall Retailer. They are designed specifically for Vauxhall models and carry a 12-month guarantee.

### TRANSMISSION

#### Six-speed manual gearbox

Standard on all models

#### Six-speed automatic transmission with ActiveSelect® function

Available on 1.6CDTi (136PS)/2.0CDTi (170PS) models.

- Electronically controlled with adaptive driving function
- Fluid drive with torque converter, lock-up clutch, neutral control fuel-saving feature and ActiveSelect®
- Steering wheel mounted paddle-shift for fingertip sequential gear changes (fitted in conjunction with VX-Line leather-covered sports steering wheel)

### STEERING

- Power-assisted steering
- Turning circle (kerb-to-kerb): – 11.4m (37.4ft.)

### SUSPENSION

**Front:** Independent. Lightweight MacPherson struts with gas-pressure dampers and coil springs. Anti-roll bar.

**Rear:** Lightweight multi-link with rising-rate mini-block coil springs and gas-pressure dampers. Anti-roll bar.

- SRi – lowered sports suspension

#### FlexRide (Adaptive Stability Technology) system

FlexRide offers drivers the choice of three distinct driving modes – Normal (default setting), Sport or Tour.

- Sport mode: This stiffens the car's suspension and sharpens steering and throttle responses. It also raises the threshold at which the ESP and traction control systems are activated, enhancing dynamic performance.
- Tour mode: Ideal for long motorway journeys, the Tour mode adjusts the dampers to a softer setting to create a perceptibly smoother ride and further enhance Insignia's ride comfort
- Continuous damping control: Utilises data from up to 11 variables including acceleration, braking and cornering to constantly control the suspension for optimum stability, driver engagement and comfort. Operates in all three driving modes
- Gas-filled rear dampers: Insignia's rear dampers are increased to 37mm diameter for enhanced performance

### BRAKES

- Anti-lock Braking System (ABS)
- Dual circuit, diagonally split braking system
- Disc brakes all round

### FUEL TANK CAPACITY

All models: 70 litres (15.4 gallons)



# INSIGNIA SPECIFICATIONS

## EXTERIOR DIMENSIONS millimetres (inches)

### Hatchback

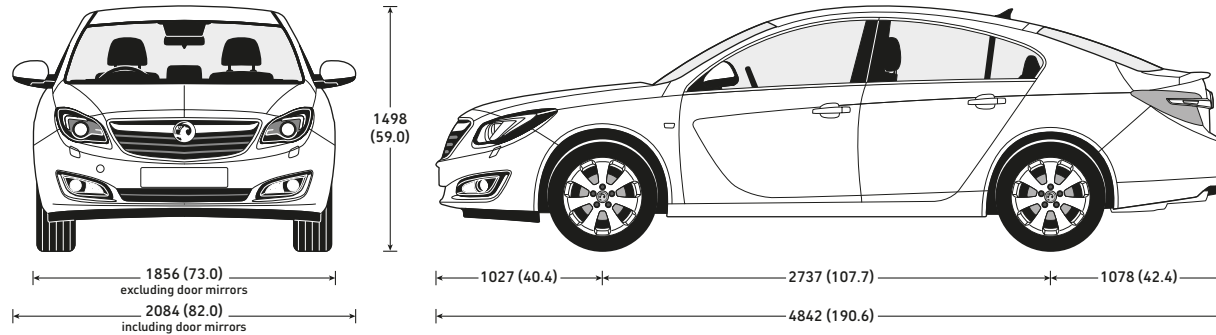

### Sports Tourer

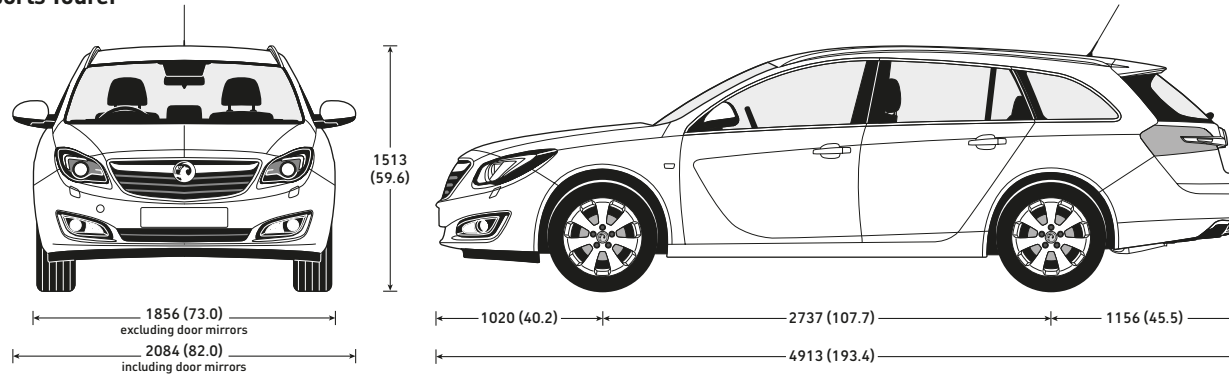

## LOADSPACE DIMENSIONS millimetres (inches)

	Sports Tourer
Maximum load floor length – rear seats folded	1908 (75.1)
Maximum load floor length – rear seats up	1086 (42.8)
Maximum rear floor width	1060 (41.7)
Maximum load area height	778 (30.6)
Loading height from ground level (unladen)	650 (25.6)
Maximum tailgate aperture width	1064 (41.9)
Maximum tailgate aperture height	684 (26.9)

## LUGGAGE CAPACITIES\* litres (cu.ft.)

	Load volume (minimum)	Load volume (maximum)
Hatchback <sup>††</sup>	530 (18.7)**	1470 (51.9) <sup>†</sup>
Sports Tourer	540 (19.0)	1530 (54.0) <sup>†</sup>

\* = Measured using the ECIE method. \*\* = Under luggage compartment cover – rear seats up.  
 † = To roof – rear seats folded. †† = When an optional full-size spare wheel or Bose® Premium Sound System is specified, luggage capacity is reduced due to a raised (10cm) luggage compartment floor.

# INSIGNIA ACCESSORIES

## INFOTAINMENT

Total (inc. VAT)

### Sat Nav updates<sup>1</sup>

Please consult your Retailer for latest map updates or visit [www.vauxhall.co.uk/accessories](http://www.vauxhall.co.uk/accessories).

1 = For use with optional factory-fit satellite navigation systems.

### CHILD SEATS<sup>2</sup>

BABY-SAFE<sup>3</sup> – 0-13kg/birth to 15 months £132.00

– ISOFIX base £227.00

DUO ISOFIX<sup>3</sup> – 9-18kg/9 months to 4 years

with top tether kit £347.00

KID<sup>3</sup> – 15-36kg or 4 to 12 years £157.00

<sup>2</sup> = Restrictions apply to the use of child seats, please consult your Vauxhall Retailer or request a copy of the Child seats brochure.

<sup>3</sup> = Without transponder.

### SAFETY

Privacy shades – rear side windows from £61.00

Privacy shades – tailgate window £154.00

Parking sensors

– four fully flush front bumper mounted sensors

– painted £350.00

– four fully flush rear bumper mounted sensors

– painted £330.00

Safety Pack – first aid kit, warning triangle,

hi-visibility vest, Vauxhall bag £35.00

Fire extinguisher – 2kg £37.00

First aid kit £15.00

Warning triangle £17.00

Hi-visibility vest £9.00

Temporary tyre inflation kit £150.00

Tyre sealant £68.00

### SECURITY

Locking wheel bolts – set of four £53.00

Steering wheel security bar £94.00

## FLEXCONNECT RANGE

Total (inc. VAT)

FlexConnect bracket £20.00

FlexConnect hook £28.00

FlexConnect coat hanger £58.00

FlexConnect folding table £68.00

FlexConnect iPad Mini cradle £98.00

FlexConnect iPad (1-4) cradle £106.00

FlexConnect iPad Air cradle £106.00

FlexConnect Samsung Galaxy cradle £96.00

## PRACTICAL

Premium spare bulb kit <sup>4</sup> from £27.00

Stretch tow rope – 3000kg £34.00

Towing bar 2500kg £85.00

Smoker pack £58.00

<sup>4</sup> = Excludes xenon headlight bulb for models with Adaptive Forward Lighting (AFL)

## PROTECTION

Rubber floor mats – set of four £59.00

Velour floor mats – set of four £82.00

Pedal covers – alloy effect from £137.00

Cargo liner – all models from £74.00

Vertical load restraint net

– Sports Tourer £265.00

Dog guard – Sports Tourer £157.00

FlexOrganiser® System – Sports Tourer

– divider bar £95.00

– side net pocket £17.00

– fixing adaptor £9.00

– side rail hook (each) £2.00

– fixing strap £35.00

– fold-flat storage box £27.00

Mudflaps front and rear<sup>5</sup> £108.00

<sup>5</sup> = Not available with certain exterior styling accessories.

## TRANSPORT SYSTEMS

Total (inc. VAT)

Roof base carrier £146.00

### Roof carriers (requires base carrier)

Bike roof carrier – Thule Freeride 532 £76.00

Surf board roof carrier – Thule 833 £101.00

Kayak roof carrier – Thule 837 £168.00

Ski roof carrier (400mm wide)

– Thule Deluxe 726 £138.00

Ski roof carrier (600mm wide)

– Thule 739 £235.00

### Hard shell roof boxes (requires base carrier)

Thule Ocean 80

(320 litre / 1330 x 860 x 370mm) £235.00

Thule Ocean 200

(390 litre / 1750 x 820 x 450mm) £316.00

Thule Dynamic M

(320 litre / 2060 x 840 x 340mm) from £625.00

Thule Dynamic L

(430 litre / 2350 x 940 x 350mm) £846.00

Thule Excellence

(520 litre / 2180 x 940 x 400mm) £898.00

Thule Motion 800

(460 litre / 2050 x 840 x 450mm) from £515.00

Thule Touring 200

(400 litre / 1750 x 820 x 450mm) £372.00

Thule Touring 780

(430 litre / 2320 x 700 x 420mm) £460.00

### Soft roof boxes (requires base carrier)

Thule Ranger 90

(280 litre / 1100 x 800 x 400mm) £285.00

Thule Ranger 500

(300 litre / 1900 x 500 x 300mm) £378.00

### Tailgate carrier

Bike tailgate carrier – Thule BacPac 973 £282.00

Fitting kit £48.00

#### Please note:

Prices shown are a fully fitted and painted, where applicable and include VAT. Please check with your local Vauxhall Retailer for details. It is advisable to ensure your insurance policy is adequate to cover additional fitted accessories. Prices correct at time of publication.

# INSIGNIA ADDITIONAL INFORMATION

## ON-THE-ROAD PRICES

To eliminate uncertainty about hidden costs when buying a new car, Vauxhall publishes on-the-road recommended retail prices (RRP) and these are shown in the pricing tables within this price guide. These prices include the recommended cost of number plates and delivery to a Vauxhall Retailer of £700.00 (including £116.67 VAT), 12 months' Government Vehicle Excise Duty (see opposite for details) and the DVLA new vehicle first registration fee of £55.00\*.

Please note: The on-the-road recommended retail price (RRP) does not include fuel supplied by the Retailer, motor insurance or any other goods or services supplied by agreement between the Retailer and the customer.

## PRICE PROTECTION

Order a new Vauxhall for build in the current model year (as confirmed by your Retailer) for delivery no more than three months in advance and the price you are quoted is the price you pay. This is irrespective of any subsequent price rises between placing your order and delivery of your new car, but you must take delivery as soon as the car is available. General Motors UK Limited is not liable for price adjustments caused by Government changes in the rate of VAT (currently 20%), Vehicle Excise Duty, DVLA new vehicle first registration fee or by any other applicable legislation or regulations.

## E10 FUEL

E10 fuel is cleared for use in all petrol-engined Vauxhall vehicles excluding models with the 2.2 litre petrol engine (code Z22YH) used in Vectra, Signum and Zafira models. Owners of these vehicles should continue to use regular unleaded or premium unleaded petrol.

## VEHICLE EXCISE DUTY

The amount of Vehicle Excise Duty (road fund licence) payable on new cars varies depending on the level of carbon dioxide (CO<sub>2</sub>) emissions produced by the vehicle. CO<sub>2</sub> emissions are measured in grammes (g) per kilometre (km) travelled and divided into 13 charging bands shown in the table below.

A 'first year rate' of Vehicle Excise Duty is payable on all new cars and in subsequent years the amount payable reverts to the 'standard rate'. From 1 April 2017 the breakpoints for each of these bands have been revised. Also, for vehicles with a list price over £40,000, including factory-fitted options, an additional £310 is payable for the first five years of standard rate payments.

### Vehicle Excise Duty\*

	CO <sub>2</sub> emissions (g/km)	First year rate	Standard rate
Band A	0	£0.00	£0.00
Band B	1-50	£10.00	£140.00
Band C	51-75	£25.00	£140.00
Band D	76-90	£100.00	£140.00
Band E	91-100	£120.00	£140.00
Band F	101-110	£140.00	£140.00
Band G	111-130	£160.00	£140.00
Band H	131-150	£200.00	£140.00
Band I	151-170	£500.00	£140.00
Band J	171-190	£800.00	£140.00
Band K	191-225	£1200.00	£140.00
Band L	226-255	£1700.00	£140.00
Band M	over 255	£2000.00	£140.00

\* = Correct at time of issue.

## PROTECTING THE ENVIRONMENT

Vauxhall's commitment to the environment is demonstrated by our products' many environmental awards. For even more information on Vauxhall's efforts to achieve an environmentally sustainable future, and how to dispose of your end-of-life vehicle, see [www.vauxhall.co.uk/recycling](http://www.vauxhall.co.uk/recycling)

## VAUXHALL ASSISTANCE

Vauxhall Assistance is provided automatically with every new Vauxhall for 12 months from first registration and covers everything from accident assistance, roadside recovery and 'at home' service to flat tyres. With Vauxhall Assistance help is literally just a free\*\* phone call away, 24 hours a day, 365 days a year!

\*\* = Mobile phone users will be charged at their standard tariff.

## VAUXHALL LEASING

As Vauxhall's own contract hire and fleet management operation, Vauxhall Leasing provides a one-stop-shop for competitive car and van leasing solutions – for business users and private individuals. Working with the Vauxhall Retailer network, we combine the support of a national contract with the convenience of a local contact.

For further information, please see your local Vauxhall Retailer or call us on **0870 737 2557**. Alternatively, you can visit our website at [www.vauxhall-leasing.co.uk](http://www.vauxhall-leasing.co.uk)

## IN THE EVENT OF AN ACCIDENT...

Vauxhall Accident Management helps keep you mobile following an accident. Benefits include vehicle recovery, Vauxhall-approved repairs and contacting your insurer. For more details, visit [vauxhall.co.uk/AccidentManagement](http://vauxhall.co.uk/AccidentManagement)

## VAUXHALL SERVICE PLAN

Vauxhall Retailers offer a great service for owners of all Vauxhall cars. Value for money, regular offers and free check-ups, combined with the peace of mind that comes from using Vauxhall-trained technicians and genuine parts, help keep your car in peak condition at all times.

## FOR MORE PRODUCT INFORMATION

For a brochure on any Vauxhall model (up to a maximum of three per caller) or location of your nearest Vauxhall Retailer please call **0345 600 1500**. Alternatively, details can be found on our website at [www.vauxhall.co.uk](http://www.vauxhall.co.uk)

## JOIN US ONLINE:



## VAUXHALL INSURANCE WITH ADDED REASSURANCE

### Comprehensive cover – Summary of benefits\*

- Competitive premiums
- Repairs by a Vauxhall-trained technician
- Genuine Vauxhall parts, guaranteed for three years when we repair your car within our Approved Repairer Network
- Free courtesy car as standard when using an Approved Repairer\*\*
- 24 hour claims helpline
- Personal Accident benefit
- Cover for audio equipment
- Windscreen cover

### Call for a quote on 0844 463 2670†

\*The benefits listed above are for comprehensive cover only. For details of Third Party, Fire and Theft cover, please call our sales team.  
\*\*Should your car need repairing following an accident we provide a courtesy car (subject to availability) for the duration of the repair. Only genuine Vauxhall parts are used. Terms and conditions apply.  
†Calls may be recorded. Vauxhall Motor Insurance is underwritten by Ageas Insurance Limited.

Every effort has been made to ensure that the contents of this document were accurate and up-to-date at the time of publication – 1 April 2017. The invoice price, including delivery to Retailer, factory-fitted options, accessories fitted by the Retailer and number plates, is subject to VAT. The right is reserved to alter specifications and prices, and withdraw products from sale, without notice. Please note that Vauxhall Retailers are not the agents of General Motors UK Limited and are not authorised to bind General Motors UK Limited by any specific or implied undertaking or representation. It is advisable to ensure that your motor insurance policy provides adequate cover for additional fitted options and accessories. All rights reserved. No part of this publication may be reproduced in any form or by any means, without the prior written permission of General Motors UK Limited.

General Motors UK Limited t/a Vauxhall, Griffin House, UK1-101-135, Osborne Road, Luton, Bedfordshire, LU1 3YT. [www.vauxhall.co.uk](http://www.vauxhall.co.uk)

©2017 General Motors UK Limited



**VAUXHALL**